













## 700x750 HERKULES X

 mm	 mm	 a b a x b	 a b a x b
700	700	750x700	750x450

	 kW	 m/min	 mm	 kg	
3x400 V	11,0	15 -80	7680x67x1,6	5950	
Lmin	Lmax	B	Hmin	Hmax	V
4000	5550	2010	2670	3050	615

\* doporučená hodnota. Při překročení doporučeného maximálního průměru není možné garantovat výkon pilového pásu!  
/recommended value. The blade performance cannot be guaranteed when the recommended diameter is exceeded!

 a x b - řezání svazků bez horního přitlaku / cutting of the bundle without top clamping/

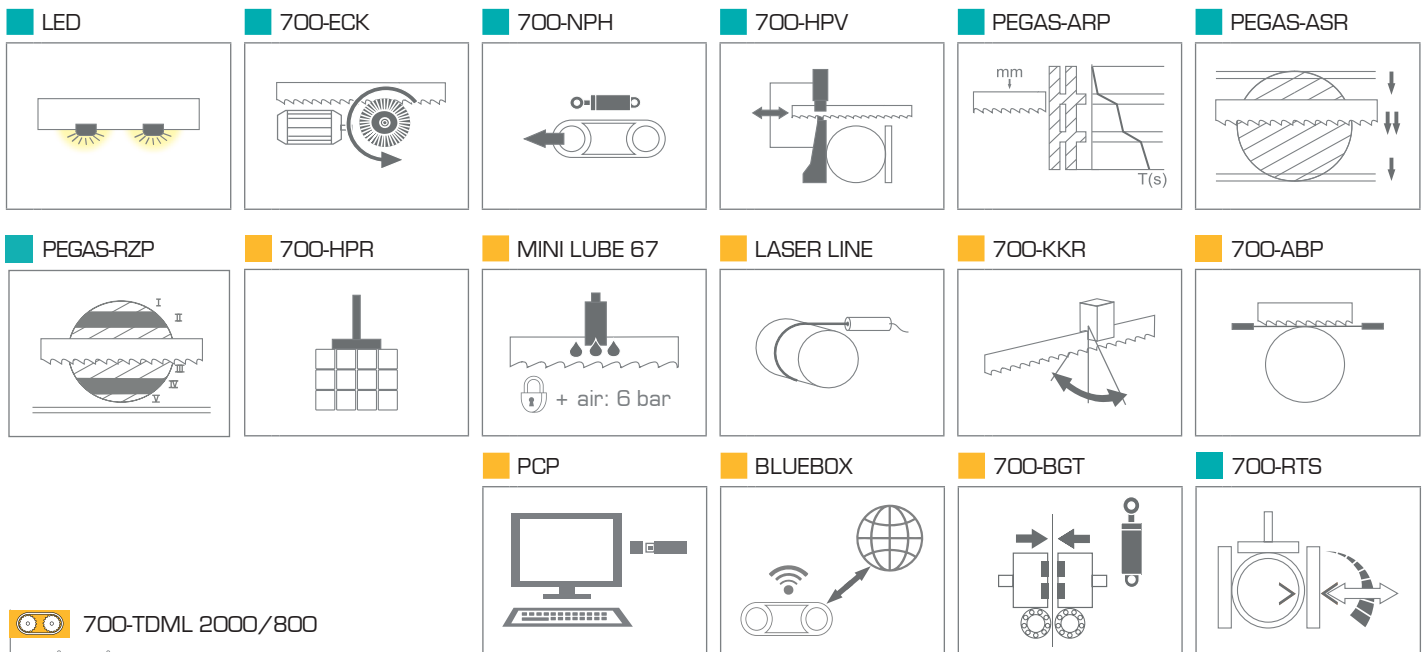

700-TDML 2000/800

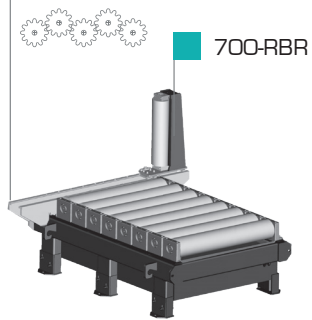

700-RBR

700-TDM 2000/800

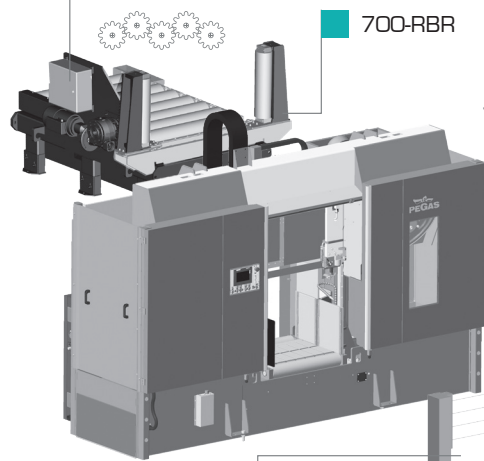

700-RBR



700-VTH

BOX-TRI-BIG

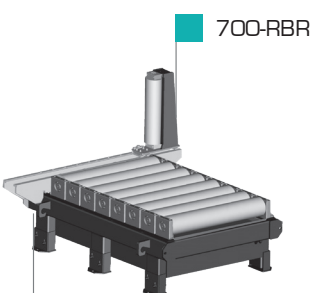

700-RBR

OZP-L 2000  
OZD-L 2000

OZP  
+RDT/TDT

OZP-D  
+RDT/TDT

OZS-D  
+RDM/TDM

OZS  
+RDM/TDM

700-LSG

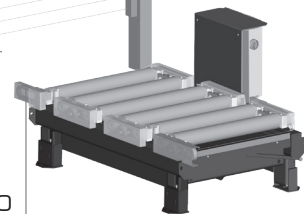

OZS-D  
+RDM/TDM

OZS  
+RDM/TDM

700-TDT 2000/800

700-V  
+RDT

700-V-NI  
+RDT

700-DMV 2000  
+RDT 2000

700-DMV 1000  
+RDT 1000

700-RDM 2000/800

700-RDML 2000/800

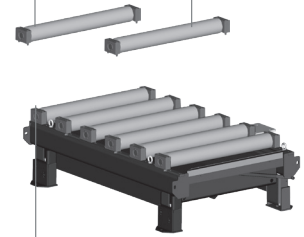

700-RDT 2000/800

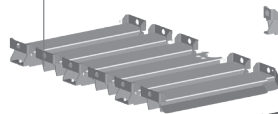

700-RDT 1000/800

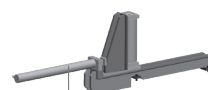
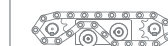

700-CSV  
+RBR



700-RBRS  
+RBR

700-RBR

# 700x750 HERKULES X

STANDARD    OPTION



PEGAS-GONDA s.r.o., Čs.armády 322, 684 01 Slavkov u Brna, CZECH REPUBLIC  
Tel: 00420-544 221 125 (126), Fax: 00420-544 227 389, E-mail: pegas@gonda.cz  
www.pegas-gonda.cz

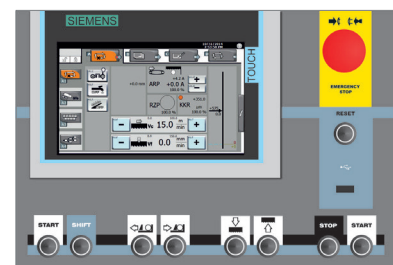

CONTROL PANEL:SIEMENS (X)

- výrobce si vyhrazuje právo provádět změny technických údajů, technické údaje odpovídají 1.3.2018  
/ producer has the right to make changes of technical data, technical data are valid on 1.3.2018 /  
- pila na fotografii není vždy v základním provedení, uvedené rozměry odpovídají stroji v základním provedení  
/ the machine in the picture is not always in the basic version, mentioned diameters are for machine in basic version /